

# The Universal Family of Marked Poset Polytopes

Christoph Pegel

Institute for Algebra, Geometry, Topology and their Applications  
ALTA, Universität Bremen

March 7, 2017

AG Diskrete Mathematik, Geometrie und Optimierung,  
Goethe-Universität Frankfurt am Main

joint with Xin Fang, Ghislain Fourier and Jan-Philipp Litza

# Outline

## Poset Polytopes

Order and Chain Polytopes

Face Structure

## Polytopes in Representation Theory

$GT(\lambda)$

$FFLV(\lambda)$

## Marked Poset Polytopes

Marked Order and Chain Polytopes

Marked Chain-Order Polytopes

## The Universal Family

Idea and Construction

H-description

Tropical Subdivision

V-description in the generic case

# Poset Polytopes

# Order and Chain Polytopes

Given a finite poset  $P$  with  $\widehat{0}$  and  $\widehat{1}$ , Stanley introduced two poset polytopes in  $\mathbb{R}^{\widetilde{P}}$ , where  $\widetilde{P} = P \setminus \{\widehat{0}, \widehat{1}\}$ .

- ▶ The *order polytope*

$$\mathcal{O}(P) = \left\{ x \in [0, 1]^{\widetilde{P}} \mid x_p \leq x_q \text{ for } p < q \right\},$$

- ▶ and the *chain polytope*

$$\mathcal{C}(P) = \left\{ x \in [0, 1]^{\widetilde{P}} \mid x_{p_1} + \cdots + x_{p_k} \leq 1 \text{ for } p_1 < \cdots < p_k \right\}.$$

## Example

Consider the poset  $P =$

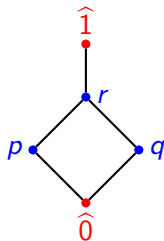

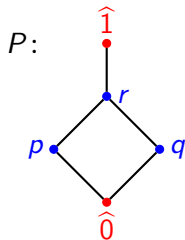

For the order polytope  $\mathcal{O}(P) \subseteq \mathbb{R}^{\{p,q,r\}}$  we just need to consider inequalities given by covering relations:

$$0 \leq x_p,$$

$$0 \leq x_q,$$

$$x_p \leq x_r,$$

$$x_q \leq x_r,$$

$$x_r \leq 1.$$

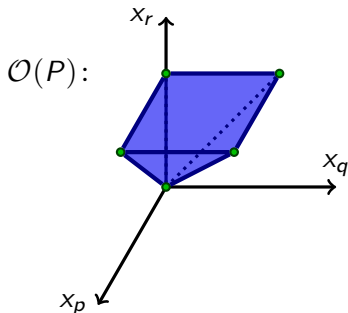

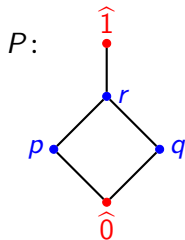

For the chain polytope  $\mathcal{O}(P) \subseteq \mathbb{R}^{\{p,q,r\}}$  we just need to consider inequalities given by maximal chains:

$$x_p + x_r \leq 1,$$

$$x_q + x_r \leq 1,$$

as well as all coordinates being non-negative:

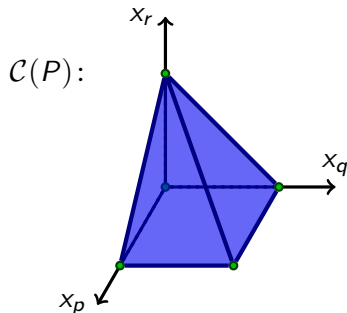

$$0 \leq x_p,$$

$$0 \leq x_q,$$

$$0 \leq x_r.$$

# Face Structure



What about the face structure of  $\mathcal{O}(P)$  and  $\mathcal{C}(P)$ ?

- ▶ The face structure of  $\mathcal{O}(P)$  has a very nice description by *connected, compatible partitions* of  $P$ .
- ▶ The face structure of  $\mathcal{C}(P)$  ...

*A description of the faces of  $\mathcal{C}(P)$  analogous to Theorem 1.2 seems messy and will not be pursued here.*

—R. P. Stanley, *Two Poset Polytopes*, 1986

However, there is a piecewise-linear bijection called the *transfer map*  $\varphi: \mathcal{O}(P) \rightarrow \mathcal{C}(P)$  given by

$$\varphi(x)_p = x_p - \max_{q \prec p} x_q.$$

This allows to transfer some properties from  $\mathcal{O}(P)$  to  $\mathcal{C}(P)$  ...

The transfer map  $\varphi: \mathcal{O}(P) \rightarrow \mathcal{C}(P) \dots$

- ▶  $\dots$  restricts to a bijection

vertices of  $\mathcal{O}(P) \longrightarrow$  vertices of  $\mathcal{C}(P)$

sending indicator functions of filters to indicator functions of anti-chains.

- ▶  $\dots$  yields an Ehrhart equivalence  $\text{Ehr}(\mathcal{O}(P)) = \text{Ehr}(\mathcal{C}(P))$ .
- ▶  $\dots$  preserves a unimodular triangulation with simplices corresponding to linear extensions of  $P$ .

# Polytopes in Representation Theory

GT( $\lambda$ )

- ▶ For a given tuple of integers  $\lambda = (\lambda_1 \geq \lambda_2 \geq \dots \geq \lambda_n)$ , there is an irreducible representation  $V(\lambda)$  of  $\mathfrak{gl}_n(\mathbb{C})$  with highest weight  $\lambda$ .
- ▶ It has as *Gelfand–Tsetlin basis* with elements enumerated by integral *GT-patterns*. For example, when  $\lambda = (5, 3, 3, 1)$ , a GT-pattern would be:

$$\begin{array}{cccc}
 & & & 5 \\
 & & & 4 \\
 & & 3 & 3 \\
 2 & & 3 & \\
 & 1 & 3 & \\
 & & 1 & \\
 & & & 1
 \end{array}$$

$\rightsquigarrow$  Lattice points in the *Gelfand–Tsetlin polytope*  $GT(\lambda)$ .

FFLV( $\lambda$ )

- ▶ The irreducible representation  $V(\lambda)$  of  $\mathfrak{gl}_n(\mathbb{C})$  has another basis called the *Feigin–Fourier–Littelmann–Vinberg basis* with elements enumerated by integral patterns of another kind:

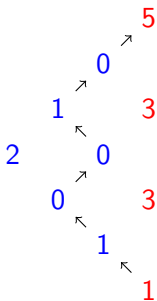

For each *Dyck path* between two **red** entries, the sum of the **blue** entries along the path should be at most the difference of the two **red** entries. In this case:

$$1 + 0 + 0 + 1 + 0 \leq 5 - 1$$

$\rightsquigarrow$  Lattice points in the *Feigin–Fourier–Littelmann–Vinberg polytope*  $\text{FFLV}(\lambda)$ .

# Marked Poset Polytopes



# Marked Order and Chain Polytopes

To generalize  $\mathcal{O}(P)$ ,  $\mathcal{C}(P)$ ,  $\text{GT}(\lambda)$  and  $\text{FFLV}(\lambda)$ , Ardila, Bliem and Salazar introduced *marked poset polytopes*.

To a finite poset  $P$ , a subset  $A \subseteq P$  containing all extremal elements, and an order-preserving *marking*  $\lambda: A \rightarrow \mathbb{R}$ , associate two polytopes in  $\mathbb{R}^{\tilde{P}}$ , where  $\tilde{P} = P \setminus A$ :

- ▶ The *marked order polytope*

$$\mathcal{O}(P, \lambda) = \left\{ x \in \mathbb{R}^{\tilde{P}} \left| \begin{array}{ll} x_p \leq x_q & \text{for } p < q, \\ \lambda(a) \leq x_p & \text{for } a < p, \\ x_p \leq \lambda(a) & \text{for } p < a \end{array} \right. \right\},$$

- ▶ and the *marked chain polytope*

$$\mathcal{C}(P, \lambda) = \left\{ x \in \mathbb{R}^{\tilde{P}} \left| \begin{array}{l} \sum_i x_{p_i} \leq \lambda(b) - \lambda(a) \text{ for } a < p_1 < \dots < p_k < b \\ x_p \geq 0 \text{ for all } p \in \tilde{P} \end{array} \right. \right\}.$$

- ▶ For a poset  $P$  with  $\hat{0}$  and  $\hat{1}$  we recover  $\mathcal{O}(P)$  and  $\mathcal{C}(P)$  as  $\mathcal{O}(P, \lambda)$  and  $\mathcal{C}(P, \lambda)$  with the marking

$$\lambda: \{\hat{0}, \hat{1}\} \longrightarrow \mathbb{R}, \quad \hat{0} \mapsto 0, \quad \hat{1} \mapsto 1.$$

- ▶  $\text{GT}(\lambda)$  and  $\text{FFLV}(\lambda)$  are the marked poset polytopes associated to the marked poset

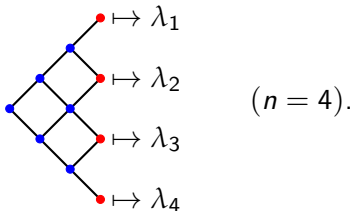

What about the face structure of  $\mathcal{O}(P, \lambda)$  and  $\mathcal{C}(P, \lambda)$ ?

- ▶ The face structure of  $\mathcal{O}(P, \lambda)$  has a very nice description by *connected,  $(P, \lambda)$ -compatible partitions* of  $P$ .
- ▶ The face structure of  $\mathcal{C}(P, \lambda)$  ... seems even messier.

However, there is a piecewise-affine bijection called the *transfer map*  $\varphi: \mathcal{O}(P, \lambda) \rightarrow \mathcal{C}(P, \lambda)$  given by

$$\varphi(x)_p = x_p - \max_{q \prec p} \begin{cases} x_q & \text{if } q \in \tilde{P}, \\ \lambda(q) & \text{if } q \in A. \end{cases}$$

This allows to transfer some (but less) results from  $\mathcal{O}(P, \lambda)$  to  $\mathcal{C}(P, \lambda)$  ...

The transfer map  $\varphi: \mathcal{O}(P, \lambda) \rightarrow \mathcal{C}(P, \lambda) \dots$

- ▶ ... **does not preserve vertices**. In fact, in general  $f_0(\mathcal{O}(P, \lambda))$  will not be equal to  $f_0(\mathcal{C}(P, \lambda))$ . (“ $\leq$ ” is an open conjecture).
- ▶ ... yields an Ehrhart equivalence of  $\mathcal{O}(P, \lambda)$  and  $\mathcal{C}(P, \lambda)$  for integral markings.
- ▶ ... preserves a subdivision into products of simplices with cells corresponding to “marking compatible” saturated chains of order ideals.

# Marked Chain-Order Polytopes

Given a marked poset  $(P, \lambda)$  and a partition  $\tilde{P} = C \sqcup O$  such that  $C$  is an order ideal in  $\tilde{P}$ , define the *marked chain-order polytope*  $\mathcal{O}_{C,O}(P, \lambda)$  in the following way:

- ▶ For  $p \in A \sqcup O$  and  $x \in \mathbb{R}^{\tilde{P}}$  let

$$z_p = \begin{cases} \lambda(p) & \text{if } p \in A, \\ x_p & \text{if } p \in O. \end{cases}$$

- ▶ For  $p < q$  with  $p, q \in A \sqcup O$  impose an inequality

$$z_p \leq z_q.$$

- ▶ For a chain  $a < p_1 < \dots < p_k < b$  with  $a, b \in A \sqcup O$  and all  $p_i \in C$  impose an inequality

$$x_{p_1} + \dots + x_{p_k} \leq z_b - z_a.$$

Note that  $\mathcal{O}_{\tilde{P}, \emptyset}(P, \lambda) = \mathcal{C}(P, \lambda)$  and  $\mathcal{O}_{\emptyset, \tilde{P}} = \mathcal{O}(P, \lambda)$ .

# The Universal Family



# Idea and Construction

## First Idea

Parametrize the transfer-map with  $t \in [0, 1]$  as

$$\varphi_t(x)_p = x_p - t \max_{q \prec p} \begin{cases} x_q & \text{if } q \in \tilde{P}, \\ \lambda(q) & \text{if } q \in A. \end{cases}$$

This piecewise-affine map is still injective and we get the following result:

### Theorem

*The image  $\varphi_t(\mathcal{O}(P, \lambda))$  is always a polytope and its combinatorial type is constant for  $t \in (0, 1)$ .*

$$\begin{array}{ccc} \mathcal{O}(P, \lambda) & & \mathcal{C}(P, \lambda) \\ \bullet & \text{---} & \bullet \\ 0 & (0, 1) & 1 \end{array}$$

## Second Idea

Parametrize the transfer-map with  $t \in [0, 1]^{\tilde{P}}$  as

$$\varphi_t(x)_p = x_p - t_p \max_{q \prec p} \begin{cases} x_q & \text{if } q \in \tilde{P}, \\ \lambda(q) & \text{if } q \in A. \end{cases}$$

This piecewise-affine map is still injective and we get the following result:

### Theorem

*The image  $\mathcal{O}_t(P, \lambda) = \varphi_t(\mathcal{O}(P, \lambda))$  is always a polytope and its combinatorial type is constant along the relative interiors of faces of the hypercube  $[0, 1]^{\tilde{P}}$ .*

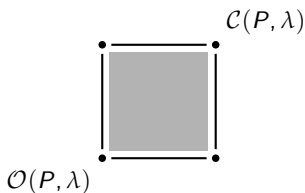

- ▶ When all  $t_p = 0$ , we have  $\mathcal{O}_t(P, \lambda) = \mathcal{O}(P, \lambda)$ .
- ▶ When all  $t_p = 1$ , we have  $\mathcal{O}_t(P, \lambda) = \mathcal{C}(P, \lambda)$ .
- ▶ When  $\tilde{P} = C \sqcup O$  where  $C$  is an order ideal in  $\tilde{P}$ , letting  $t = \chi_C$ , we have  $\mathcal{O}_t(P, \lambda) = \mathcal{O}_{C,O}(P, \lambda)$ .
- ▶ When  $\tilde{P} = C \sqcup O$  is an arbitrary partition,  $t = \chi_C$  yields what has been suggested by Fang and Fourier as *layered marked poset polytopes*.

Since we have a transfer map  $\mathcal{O}(P, \lambda) \rightarrow \mathcal{O}_t(P, \lambda)$  by construction, we can use it to get a straightforward proof of the following theorem.

### Theorem

For an integrally marked poset  $(P, \lambda)$ , the polytopes  $\mathcal{O}_t(P, \lambda)$  for  $t \in \{0, 1\}^{\tilde{P}}$  form an Ehrhart-equivalent family of normal lattice polytopes.

Since the combinatorial type of  $\mathcal{O}_t(P, \lambda)$  is fixed along relative interiors of faces of  $[0, 1]^{\tilde{P}}$ , we may think of all marked poset polytopes as continuous degenerations of the *generic marked poset polytope* for  $t \in (0, 1)^{\tilde{P}}$ .

## Goal

Understand the face structure of the generic marked poset polytope and figure out how it degenerates to the rest of the marked poset polytopes.

This might still “be messy”, but ...

- ▶ we have a common H-description of all  $\mathcal{O}_t(P, \lambda)$  and
- ▶ we can describe the vertices of the generic marked poset polytope by means of a polyhedral subdivision.

# H-description

We can describe the marked poset polytope  $\mathcal{O}_t(P, \lambda)$  for  $t \in [0, 1]^{\tilde{P}}$  as the set of points in  $\mathbb{R}^{\tilde{P}}$  satisfying the following linear inequalities:

- ▶ For each saturated chain  $a \prec p_1 \prec \cdots \prec p_k \prec b$  with  $a, b \in A$  and all  $p_i \in \tilde{P}$  an inequality

$$t_{p_1} \cdots t_{p_k} \lambda(a) + t_{p_2} \cdots t_{p_k} x_{p_1} + \cdots + x_{p_k} \leq \lambda(b)$$

- ▶ For each saturated chain  $a \prec p_1 \prec \cdots \prec p_k \prec p_{k+1}$  with  $a \in A$  and all  $p_i \in \tilde{P}$  an inequality

$$(1 - t_{p_{k+1}})(t_{p_1} \cdots t_{p_k} \lambda(a) + t_{p_2} \cdots t_{p_k} x_{p_1} + \cdots + x_{p_k}) \leq x_{p_{k+1}}.$$

# Tropical Subdivision



## Definition

The marked order polytope  $\mathcal{O}(P, \lambda)$  has a polyhedral subdivision into maximal regions of affine linearity with respect to the transfer map  $\varphi$ . Call this the *tropical subdivision*.

Why tropical?

- ▶ The regions are determined by the loci of non-differentiability of the tropical affine linear forms

$$\max_{q \prec P} \begin{cases} x_q & \text{if } q \in \tilde{P}, \\ \lambda(q) & \text{if } q \in A \end{cases} = \bigoplus_{q \prec P} \begin{cases} 0 \odot x_q & \text{if } q \in \tilde{P}, \\ \lambda(q) & \text{if } q \in A. \end{cases}$$

- ▶ Hence, we are intersecting  $\mathcal{O}(P, \lambda)$  with the chambers of an affine tropical hyperplane arrangement.

## V-description in the generic case

By construction the tropical subdivision of  $\mathcal{O}(P, \lambda)$  transfers to all  $\mathcal{O}_t(P, \lambda)$  via the transfer map  $\varphi_t$ .

### Theorem

*For generic marked poset polytopes, that is when  $t \in (0, 1)^{\tilde{P}}$ , the vertices that appear in the tropical subdivision of  $\mathcal{O}_t(P, \lambda)$  are exactly the vertices of  $\mathcal{O}_t(P, \lambda)$ .*

Let us finish with a visualization of the theorem on vertices of generic marked poset polytopes . . .

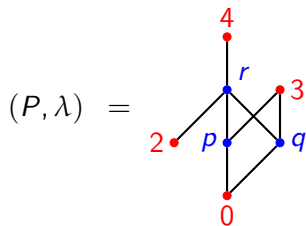
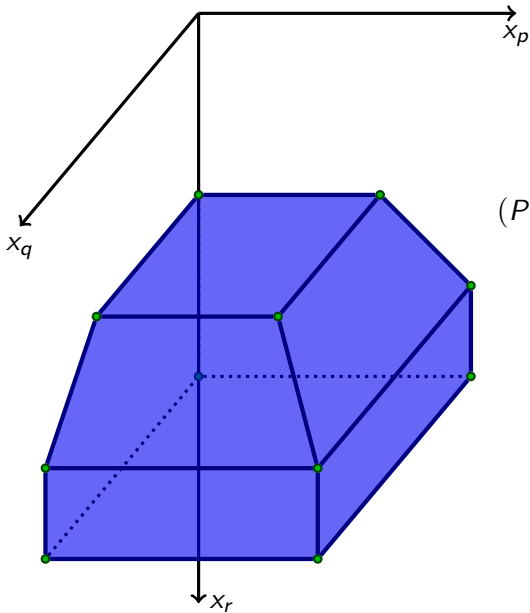

$$t_r = 0$$

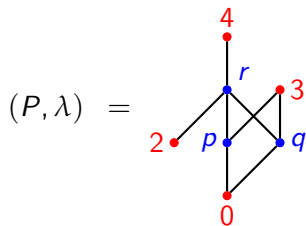
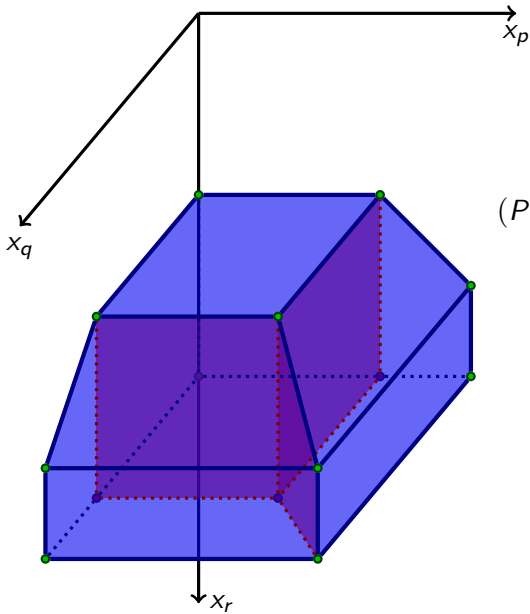

$$t_r = 0$$

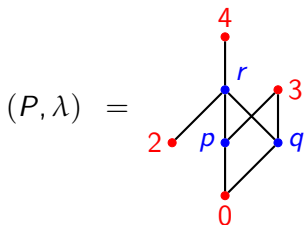
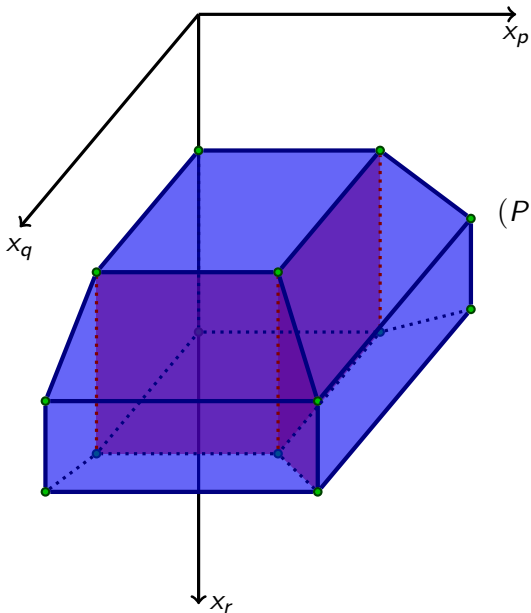

$$t_r = \frac{1}{4}$$

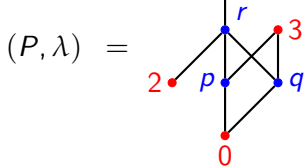
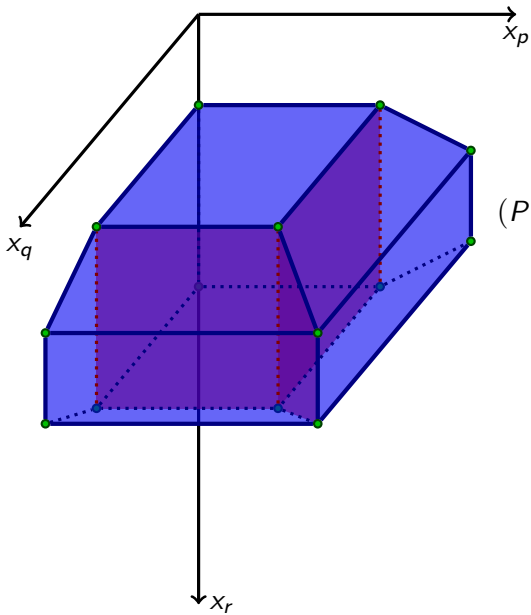

$$t_r = \frac{1}{2}$$



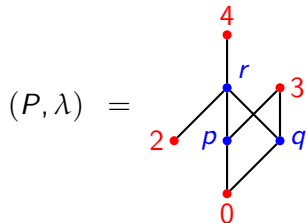
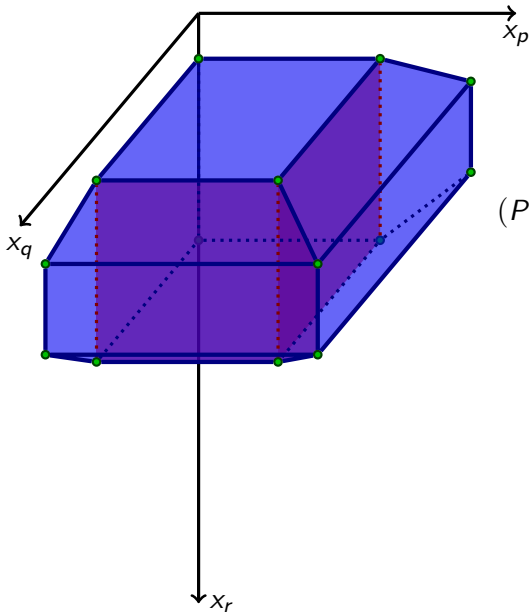

$$t_r = \frac{3}{4}$$

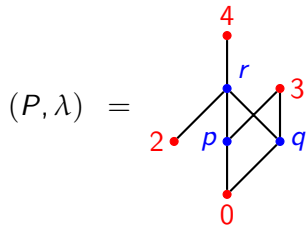
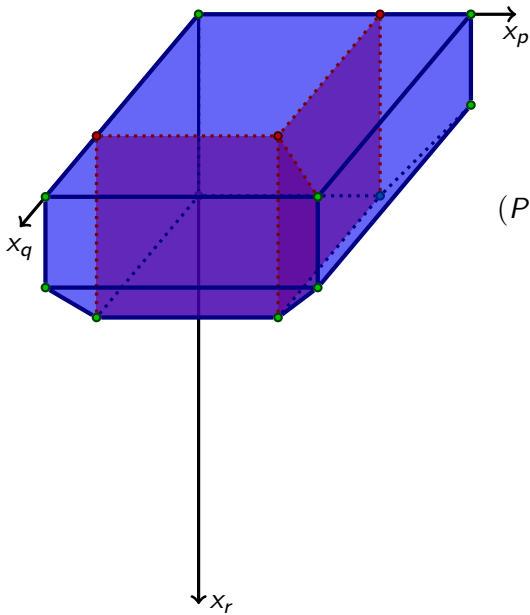

$$t_r = 1$$

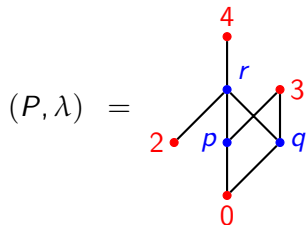
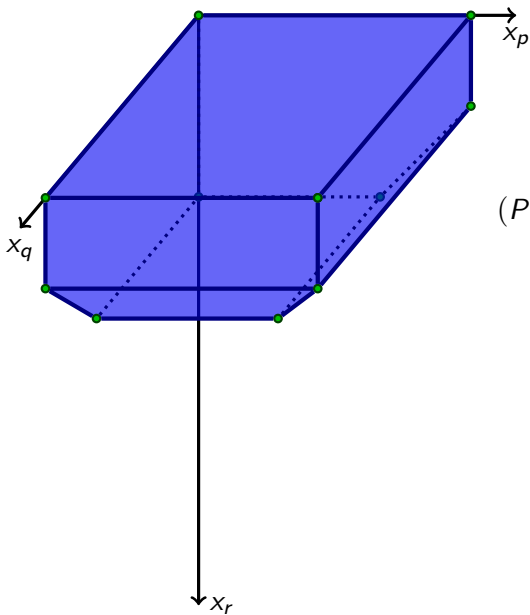

$$t_r = 1$$

Thanks for your attention!